

Herman

3-SEATER SOFA



Herman is popular and retro-inspired with a soft, rounded form. The combination of attractive, well thought-out details of the characteristic buttons in the backrest and its attractive shape give it an air of quality and a touch of the 1950s.

SOFACOMPANY

MATERIAL COMPONENTS

Frame: FSC wood 100%
Foam: High Resilience Fire Retardant Foam
Legs: Wood: FSC wood 100%
Surface meets requirements of.:
Reach, Painted: standard 16 CFR 1303 – PASS

SAFETY AND STABILITY

Our products are always developed and tested against EN 16139. 1 & 2.
EN-1021 1 & 2, BS5852 0 & 1, CA TB 117-2013.

PACKAGING MATERIAL & SHIPPING

The use of packaging materials are minimized without compromising protection of the product during transport. Chairs and sofas are protected in a cardboard box and when needed wrapped in a protective layer of recycled plastic. Shipping and transportation is in addition CO2 neutral.

PACKAGE MEASUREMENTS

62 x 183 x 79 cm, 40 kg

WARRANTY

Warranty against manufacturing defects (materials and craftsmanship) is standard as follows:

Frame: Lifetime
Foam: 5 years
Upholstery/Fabric: 5 years

Wear, tear and damages to the products are not covered under this warranty.

TEXTILE

See our textiles [here](#)

DESIGNER

Christian Rudolph

3-SEATER SOFA

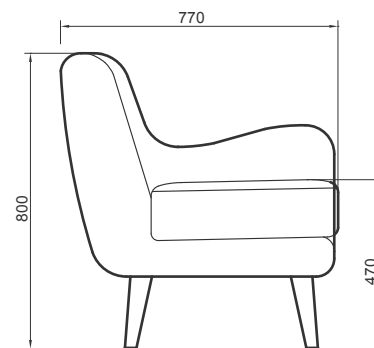
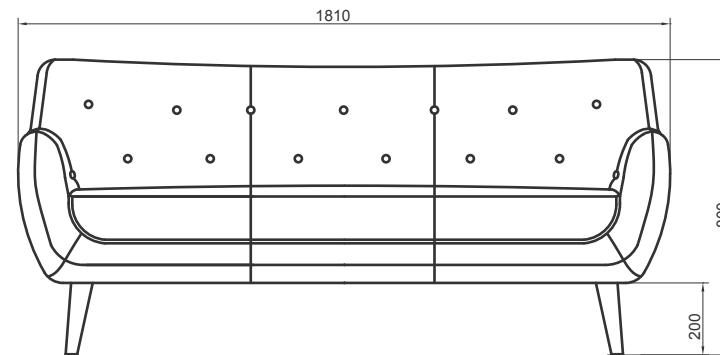

2-SEATER SOFA

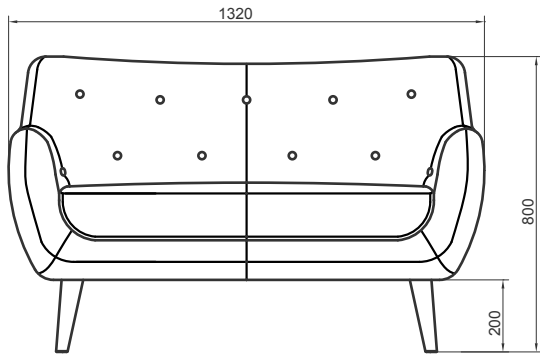

LOUNGE CHAIR

